



MANTA

Tablet DUO POWER

M I 701QC

INSTRUKCJA OBSAUGI
USER'S MANUAL
BEDIEN UN GSAW WEISUN G
MANUAL D EUSUARIO
MANUALE UTENTE
NOTICE D'UTILISATION
!" # & / ! #
MANUAL DE INSTRUÇÕES
UPUTA RUKOVANJA
NÁ VODK OBSLŮZ E
NAUDOJIMO INSTRUKCIJA

UWAGA! Wszystkie ilustracje w tej instrukcji załączono tylko dla orientacji. Podane informacje mogą podlegać zmianom bez uprzedniego powiadomienia.







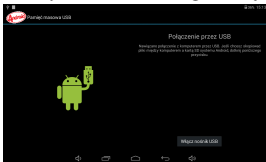



Podłączenie komputera

Używając portu USB do łączenia MID z komputerem. Pojawi się symbol ikony USB , a po przeciągnięciu i upuszczeniu paska stanu, pojawi się następujący ekran:

Wciśnij „Turn on USB storage” („Włącz nośnik USB”).



Ustawienia

-  **Wi-Fi** – umożliwia konfigurację i połączenie z siecią Wi-Fi
-  **Dźwięk** – umożliwia konfigurację dźwięków systemowych i powiadomień
-  **Wyświetlacz** – Umożliwia konfigurację wyświetlacza (Jasność ekranu, Tapeta, Uśpienie, itp.)
-  **Pamięć** – pokazuje ilość wolnej i zajętej pamięci
-  **Bateria** – pokazuje czas pracy na baterii oraz wykorzystanie przez aplikacje
-  **Język, klawiatura, głos** – umożliwia wybór języka, klawiatury, konfigurację funkcji głosowych
-  **Kopia i kasowanie danych** – umożliwia tworzenie kopii systemu oraz przywracanie ustawień fabrycznych
-  **Dodaj konto** – umożliwia dodawanie i konfigurację kont Google, Poczty, IMAP i innych
-  **Data i czas** – umożliwia ustawienie daty i czasu
-  **Informacje o urządzeniu** – Wyświetla informacje o urządzeniu, wersję systemu, numer modelu, itp.

Appearance and button

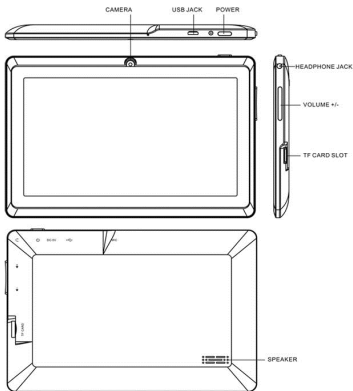

POWER

Startup: Long Press and hold the power button, the system will enter the main interface

Shutdown: In the main menu interface, Press the power button about 5 second to shutdown, The system can hint "power off" option, Clিকে "ok". you can safely shut down.

Lock screen: Short press Power button to lock screen or unlock screen.

Volume +, Volume-: The buttons on top Volume +, Volume- achieve changes in the volume.

Earphone jack: 3.5 mm standard earphone jack

TF card – Slot for MicroSD card

Micro USB – you can use it to connect the computer for data transmission and external connection USB flash drive

Main interface describe

After startup will enter the main interface

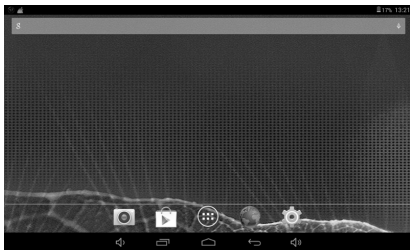

Management main interface software ICONS: long press the icons 3 second, after the icons will bigger, then you can drag anywhere in the interface.

Delete icons: long press the icons 3 second, drag the icons to the Recycle Bin icon, once it become red, Loosen your hand, after that you can delete icon

Status bar describe

The status bar at the bottom of the screen.



From left: VOLUME button, reversing button, return to the main screen, the last open application, volume + button.

The status bar at the top of the screen.



From right to left: the battery status icon, the set time, system icons.







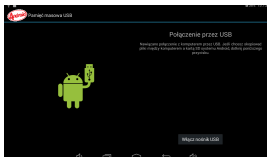



Connection with PC

Using the USB port to connect the tablet to the computer. Symbol appears on the USB icon, and drag and drop the status bar, you will see the following screen:

Click "Turn on USB storage"



Settings:

-  **Wifi** - allows you to configure and connect to a Wi-Fi
-  **Sound** - allows you to configure system sounds and notifications
-  **Display** - Allows you to configure the display (brightness of the screen, wallpaper, Sleep, etc.)
-  **Memory** - shows the amount of free and used memory
-  **Battery** - shows the battery life and the use by applications
-  **Language, keyboard, voice** - allows you to select the language, keyboard, voice feature configuration
-  **Copy and delete data** - allows you to backup and restore the system to factory settings
-  **Add Account** - You can add and configure your Google Accounts, Mail, IMAP, and other
-  **Date and time** - to set the date and time
-  **Correct information on the device** - Displays information about the device, system version, model number, etc.

Aussehen und Tasten

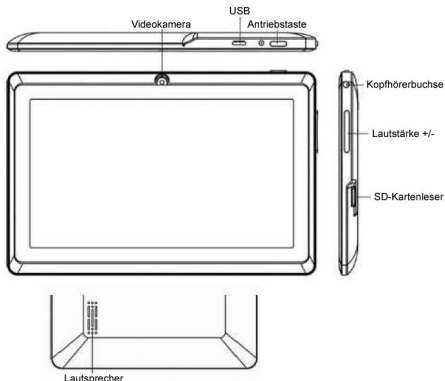

Antriebstaste (POWER)

Anschalten: wenn Sie die Antriebstaste drücken und gedrückt halten, wechselt das System zum Hauptbildschirm.

Bildschirm Sperre: nach dem kurzen Drücken auf die Antriebstaste („Power“) wird der Bildschirm gesperrt oder entsperrt.

Lautstärke +, Lautstärke - mit den oberen Tasten, „Volume+“ und „Volume -“ kann das Lautstärkeniveau erhöht oder verringert werden.

Kopfhörerbuchse – Buchse für den 3,5 mm Standardkopfhörerstecker.

Speicherkarte - TF-CARD Schlitz: externe TFFLASH Speicherkarte.

Mikro USB – zum Anschließen des Computers an die Datentransmission und Anschließen eines externen USB flash Antriebs.

Beschreibung des Hauptbildschirms

Nach dem Einschalten wird der Hauptbildschirm angezeigt.

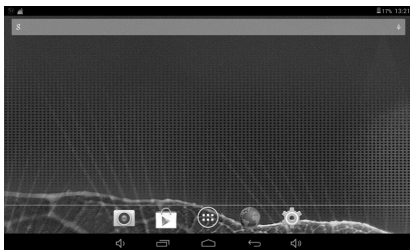

Management von Programmicons: drücken Sie ein Icon für 3 Sekunden, um es zu vergrößern und anschließend an eine beliebige Stelle auf dem Bildschirm zu ziehen.

Löschen von Icons: drücken Sie ein Icon 3 Sekunden lang, ziehen Sie es danach bis zum Papierkorb (Recycle Bin Icon), und wenn es rot wird, kann es losgelassen und gelöscht werden.

Beschreibung der Statusleiste

Statusleiste unten im Bildschirm.



Von links: VOLUME-Taste, Rücktaste, um zum Hauptbildschirm zurückzukehren, die letzte offene Anwendungsvolumen + Taste.

Die Statuszeile an der Oberseite des Bildschirms.









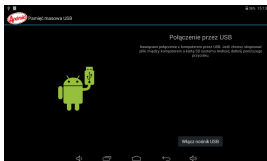



Von rechts nach links: der Batteriestatussymbol, der eingestellten Zeit, System-Icons.

Computeranschluss

Beim Benutzen des USB-Anschlusses für MID-Verbindungen mit dem Computer. Es erscheint ein USB-Iconsymbol, und nach dem Durchziehen und Loslassen der Statusleiste erscheint der folgende Bildschirm: „Turn on USB storage“ drücken („USB-Speicher anschalten“).



Einstellungen

-  **Wi-Fi** – ermöglicht die Konfiguration und Verbindung mit dem Wi-Fi-Netz
-  **Ton** – ermöglicht die Konfiguration von Systemtonsignalen und Benachrichtigungen
-  **Display** – ermöglicht die Konfiguration des Displays (Bildschirmlichtstärke, Hintergrundbild, Standbymodus, u. Ä.)
-  **Speicher** – zeigt den besetzten und freien Speicherplatz an
-  **Batterie** – zeigt die Dauer des Batteriebetriebs und Nutzung durch Applikationen
-  **Sprache, Tastenfeld, Ton** – ermöglicht die Wahl der Sprache, des Tastenfelds, die Konfiguration von Tonfunktionen
-  **Kopie und Datenlöschen** – ermöglicht die Erstellung von Systemkopien und Rückkehr zu Werkeinstellungen
-  **Konto hinzufügen** – ermöglicht das Hinzufügen und Konfigurieren von Google-, Post-, IMAP- und anderen Konten
-  **Datum und Zeit** – ermöglicht die Einstellung von Datum und Uhrzeit
-  **Gerätsdaten** – Zeigt die Daten des Geräts, Systemversion, Modellnummer, u. Ä. an.

Descripción de pantalla principal

Después de encender el dispositivo, aparece la pantalla principal.

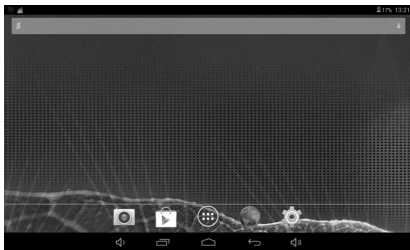

Administración de iconos de programas: pulsar el icono durante 3 segundos, para aumentar y desplazar a cualquier lugar de la pantalla.

Eliminar iconos: pulsar durante 3 segundos, desplazar el icono a la papelera y soltar, cuando se vuelva roja. Seguidamente, eliminar el icono.

Descripción de barra de estado

Barra en la parte inferior de la pantalla



Desde la izquierda: botón de volumen, botón de marcha atrás, volver a la pantalla principal, el último volumen de aplicación abierta + botón.

La barra de estado en la parte superior de la pantalla.



De derecha a izquierda: el icono de estado de la batería, el tiempo establecido, los iconos del sistema.







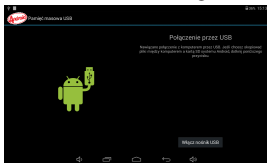



Conectar al ordenador

Utilizar el puerto USB, para conectar el dispositivo MID con el ordenador. Aparece un icono USB, desplazar y soltar el icono sobre la barra de estado, para abrir siguiente pantalla:

Pulsar „Turn on USB storage” („Conectar dispositivo USB”).



Configuración

-  **Wi-Fi**- permite configurar y conectar a red Wi-Fi
-  **Sonido** - permite configurar los sonidos del sistema y
-  **Pantalla**- permite configurar la pantalla (brillo, escritorio, protector etc.)
-  **Memoria**- muestra el espacio disponible y ocupado en la memoria
-  **Batería**- indica el tiempo de trabajo de batería y el consumo de energía por aplicaciones
-  **Idioma, teclado, voz**- permite elegir el idioma, el teclado y configurar funciones de voz
-  **Copia y borrado de datos**- permite crear una copia del sistema y recuperar la configuración inicial del dispositivo
-  **Añadir cuenta**- permite añadir y configurar cuentas Google, Correo, otros
-  **Fecha y hora**- permite ajustar la fecha y hora
-  **Informaciones acerca del dispositivo**- Muestra informaciones relativas al dispositivo, versión del sistema, número de modelo, etc.

Aspetto e pulsanti

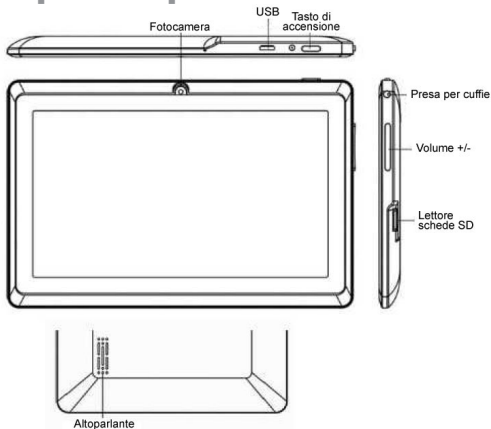

Tasto di accensione (POWER)

Attivazione: premere e mantenere premuto il tasto di accensione per qualche istante; il sistema passa allora alla schermata principale.

Blocco dello schermo: dopo una breve pressione del tasto di accensione („Power“) lo schermo viene bloccato o sbloccato.

Volume +, Volume -. Con i tasti in alto, „Volume +“ i „Volume -“ il volume aumenta o diminuisce.

Preso per cuffie – Il Jack per cuffie standard da 3,5 mm.

Scheda di memoria - Slot TF-CARD: scheda di memoria esterna TFFLASH.

Micro USB – per il collegamento ad un computer per trasmissione dati e per il collegamento di un flash drive USB esterno.

Descrizione dello schermo principale

Dopo l'attivazione, viene visualizzata la schermata principale.

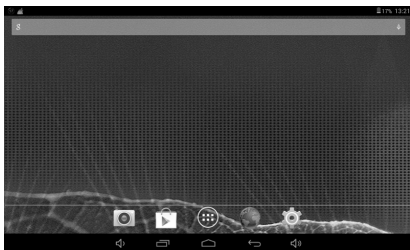

Gestione delle icone premendo il coprischermo per 2 secondi, si apre il riquadro di personalizzazione in cui si possono modificare le icone sullo schermo.

Per rimuovere le icone e i widget premendo per 3 secondi, si trascina l'icona all'indirizzo del cestino, quando diventa scura, la si lascia cadere per rimuoverla.

Descrizione della barra di stato

Barra di stato nella parte inferiore dello schermo.



Da sinistra: il tasto VOLUME, pulsante di inversione, tornare alla schermata principale, l'ultimo volume applicazione aperta + tasto.

La barra di stato nella parte superiore dello schermo.



Da destra a sinistra: l'icona di stato della batteria, il tempo impostato, icone di sistema.







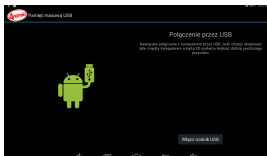



Collegamento del computer

Utilizzando la porta USB per connettere la MID con il computer. Appare l'icona USB, e dopo aver trascinato e rilasciato la barra di stato, viene visualizzata la seguente schermata:

Fai clic su „Turn on USB storage” („Attiva il supporto USB”).



Impostazioni

-  Wi-Fi consente di configurare e connettersi alla rete Wi-Fi
-  Suono consente di configurare i suoni ed i messaggi del sistema
-  Display (Visualizzazione) consente di configurare il display (schermo, Carta da parati, Standby, ecc.)
-  Memoria mostra la memoria totale in uso e la quantità
-  Batteria indica la durata di vita della batteria e l'utilizzo
-  Lingua, tastiera, voce permette di selezionare la lingua, la generazione delle funzioni vocali
-  Copia di backup e cancellazione consente di creare una copia di backup del sistema e di ripristinare le impostazioni di fabbrica
-  Aggiungi account permette di aggiungere e configurare gli account Mail, IMAP, e altri
-  Data e ora permette di impostare la data e ora
-  Informazioni sul dispositivo visualizza le informazioni sul dispositivo, versione del sistema, numero di modello, etc.

Aspe c t x t é r i e u x b o u t o n s

Bouton d'alimentation (POWER)

Allume et appuie sur le bouton d'alimentation et le maintient appuyé pendant l'installation du système passe à l'écran d'accueil.

Bloque l'écran en appuyant brièvement sur le bouton d'alimentation (Power) pour bloquer ou débloquer l'écran.

Volume, Volume et bouton de haut volume et Volume permettent de monter ou de baisser son.

Prise de sécurité - Prise normale pour jack de 3,5 mm.

Carte de mémoire Flash - CAR: Carte de mémoire externe TF FLASH.

Micro USB - Prise pour connecter ordinateur et transmettre des données pour connecter disque externe USB Flash.

Description de l'écran d'accueil

Après allumage, l'écran d'accueil s'affiche.

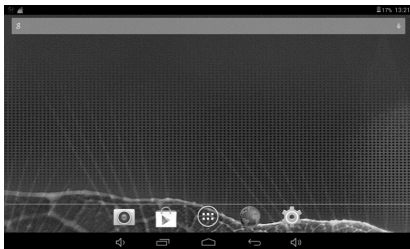

Gérez les icônes de logiciels et les icônes d'applications pendant le second démarrage. Il est alors possible de déplacer les éléments sur l'écran.

Supprimez les icônes : appuyez sur une icône pendant le second démarrage sur l'icône de corbeille ; la tâche se termine et l'icône est supprimée.

Description de la barre sur l'écran

Barre d'état en bas de l'écran.



De droite à gauche : icône de batterie, icône de mise en veille, icône de système.

La barre d'état en haut de l'écran.









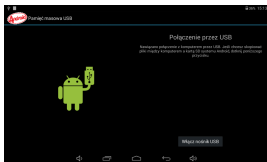



De droite à gauche : icône de batterie, icône de mise en veille, icône de système.

Connexion à l'ordinateur

Utilisez le port USB pour une connexion à l'ordinateur. L'icône de l'USB apparaît à l'écran lorsque l'appareil est connecté à un ordinateur. Appuyez sur l'icône « Allumer le support USB ».



Réglages

-  Wi-Fi permet de configurer et de connecter au réseau
-  Son permet de configurer les sons système et ceux de l'appareil
-  Afficheur permet de configurer l'afficheur (luminosité, mode veille, etc.)
-  Mémoire indique la mémoire libre et la mémoire occupée
-  Batterie indique le temps de travail disponible et la consommation des logiciels
-  Langue, clavier, sons permet de sélectionner la langue, le clavier et les sons
-  Copie et suppression des données permet de faire une copie système et de restaurer les reliages d'usine
-  Ajouter un compte permet d'ajouter et de configurer les comptes Google, mail, IMAP et autres
-  Date et heure réglage de la date et de l'heure
-  Informations sur le dispositif affiche des informations sur le dispositif, la version du système, le numéro du modèle, etc.

Изглед и бутони

CB>7070E@0=20(POWER)
 ;;NG20=5;54=0B8A:0=85B>>4J;3>@84J@6=045CB>70
 70E@0=20A=5/BB5<0@5<8=02<0;02=50@0=
 ;>:8@>2=05:@0=AQ,54@0B=9B8A:0=05CB>7070E@0=20=5B>
 („Power#0)ABJ129:8@0=8451;>:8@=0655@0=0.
 !8;0=072C:0,!8;0=072C:0!1CB>=8B50,5V,olume6+”
 „Volum”A5C25;8G028=0<0;O28;0B=072C:0.
 =574>0A;CH0;;8B5=574=0AB0=40@:B=807.0A;CH0;;8
 3,5m.
 0@B0?0<5B@>F5F-CAR2D)=H=0@B0?0<5BFFLASH.
 8:@\JSB-702;;NG20=0><?NBJ70B@0=A<8A400=8
 2;;NG20=502\=H=20>4SBIash.

Описание на главния екран

! ; 5 4 2 : ; N G 2 0 = 5 5 > ; : 0 7 2 0 0 2 = 8 5 0 @ 0 = .

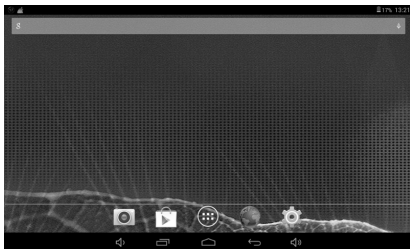

1 A ; C 6 2 0 = 5 B 3 @ > 3 @ 0 < 8 B 5 A ; 5 4 = 0 B 8 A : 0 = 5 0 B >
8 : > = 0 B 0 @ > 4 J ; 6 5 = 0 5 A 5 : C = 4 8 A 5 C 2 5 ; 8 G 0 2 0 > 3 0 2 0
< > 6 3 0 1 J 4 5 @ 5 < 5 A 2 3 @ 0 > 8 7 2 x ; G A 2 J @ B C @ 0 = 0 .

B A B @ 0 = C 2 0 ÷ 5 = 8 B A 5 4 0 B A 5 = 0 B 8 A 7 = 0 5 A 5 : C = 4 8 ,
? @ 5 < 5 A B 3 0 > = 0 B 0 : > H 7 0 A < 5 B : > 3 0 A B 0 = 5 5 @ 2 5 = 0 ,
< > 6 3 0 1 J 4 5 C A = 0 B ; 5 , 4 > 5 B 8 : > = 0 B 6 B A B @ 0 = 0 2 0 .

Описание на лентата на състоянието

5 = B 0 B 0 A J A B > O = 2 5 B > 0 B 0 A B 5 : @ 0 = 0 .



B ; 0 2 x : C B V 4 0 L U M E C B 7 4 7 0 4 5 E => 4 , 5 2 J @ = 5 B 5
> A => 2 5 8 @ 0 ? => A ; 5 4 = 8 B 2 > @ 5 5 < > ; 1 0 1 C B > = 0 .
5 = B 0 B 0 A J A B > O = 2 3 B @ = C B 0 A B 5 : @ 0 = 0 .



B 4 0 A = 2 ; 0 2 8 : > = 0 B 0 A J A B > O = 8 0 B B 5 @ 8 0 B 0 ,
7 0 4 0 4 5 = 2 0 5 < 5 8 A B 5 8 ÷ 8 = 8 .

Включване на компютъра

7 ? > ; 7 2 0 9 > 8 @ B S E 7 0 A 2 J @ 7 2 M H D A : > < ? N B J @ 0 .
 > O 2 O 2 6 A 8 < 2 > 7 0 8 : > = 0 B S B 0 A ; 5 4 @ 5 < 5 A B 2 8 = 5 B >
 ? C A : 0 = 5 B ; 5 = B 0 B 0 A J A B > O = 8 5 7 B > O 2 O 2 ; 5 4 = 8 O B
 5 : @ 0 = :
 0 B 8 A = ; 8 j u r n U S B s t o r a g e " : ; N G < > A 8 B 5 ; 5 B ")

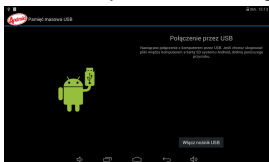

Настройки

-  Wi-Fi?>72>;O20 40 A5=0AB@>8 :>=D83C@0F80B0 8 2 @J7:0B0 A <
2C: -?>72>;O20 40 A5=0AB@>8 :>=D83C@0F80B0 =0 72CF8B5=0
C254><O20=8OB0
-  8A?;59 -?>72>;O20 40 A5=0AB@>8 :>=D83C@0F80B0 =0 48A?;5O
5: @0=0, "0?5B, 568<=0=50:B82=>AB 84@.)
-  0<5B ?>:0720 :>;8G5AB2>B>=0 A2>1>4=0B0 C 705B0B0 ?0<5B
0B5@80>:0720 2 @5<5B>=0 @01>B0B0 =0 10B5@80B0 8 87?>;72
0?;8:0F80B0; ;:0280BC@0, ;>072>;O20 40 A5 8715 @5 578:0,
;:0280BC@0B0, :>=D83C@0F80B0 =0 DC=:F88B5 =0 3;0A0
-  >?85 8 87B @820=5=0 40?>72>;O20 AJ74020=5B>=0 :>?85=0
A8AB5<0B0 8 2 @JI0=5 :J< D01 @8G=8B5=0AB@>9:8
-  >1028 :>=B?>72>;O20 4>102O=5B> 8 :>=D83C@0F80B0 =0 :>=B0
>I0B0, IMAP 84@C38
-  0B0 8 2 @5<5>72>;O20 40 A5=0AB@>8 40B0B0 8 2 @5<5B>
=D>@<0F80 70 CAB @>9AB2B8=D>@<0F80 70 CAB @>9AB2>B>
25 @A80B0 =0 A8AB5<0B0, =><5 @0=0 <>45;0 84@.

Aspectos

Botão de energia (POWER)

Ligação: deposite o smartphone no dock de potência do sistema principal.

Bloqueio da tela: deposite o botão de potência (Power) por curto tempo e o bloqueio será desbloqueado.

Volume: Volume e Combosacim, volume + Volume é aumentado e o volume é reduzido.

Suete para o auscultador: Suete para a entrada de auscultador de 3,5mm.

Cartão de memória – Slot F-CARD Cartão de memória externo TF FLASH.

MicroUSB – para conectar o computador para transmissão de dados e conexão USB externa.

Desçã o d a t e l a p r i n c i p a l

Após a ligação, aparece a tela principal.

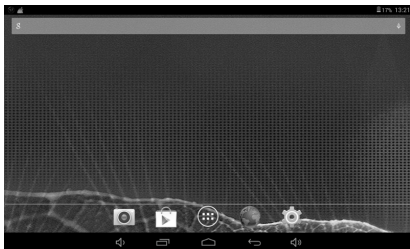

Se o ícone de um programa não estiver premido por 3 segundos, este será aumentado e poderá ser arrastado para qualquer tela.

Se o ícone de um programa não estiver premido por 3 segundos, o ícone não ficará vermelho e não será removido.

Desçã o d a b a r r a d e e s t a d o

Barra de estado abaixo na tela.



A partir da esquerda, a opção de volume, a opção de silenciosidade, e a opção de voltar à tela principal. A opção de volume e a opção de silenciosidade.

A barra de status no topo da tela.



Da direita para a esquerda: o ícone de status da bateria, o tempo definido, ícones do sistema.







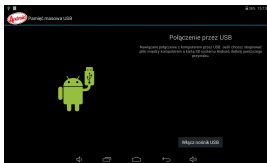



Conectar o computador

Quando o Mi Da computador for usado em modo de armazenamento USB, a conexão com o computador é feita através do cabo USB. Quando conectado ao computador, o dispositivo pode ser usado para transferir arquivos e dados para o computador. O ícone de armazenamento USB será exibido na barra de notificações e no ícone de armazenamento USB será exibido na barra de status.

Primeiro, conecte o cabo USB ao dispositivo e ao computador.



Ajustes

-  Wi-Fi – permite a conexão com a rede Wi-Fi
-  Som – permite a configuração de sistema e avisos
-  Tela – permite configurar a tela (claridade, fundo)
-  Memória – mostra a quantidade de memória livre e ocupada
-  Bateria – mostra o tempo de trabalho da pilha e o aplicativo em uso
-  Língua e teclado – permite selecionar língua, teclado e funções de voz
-  Cópia e backup – permite criar cópias do sistema e selecionar ajustes originais
-  Adicionar contas – permite adicionar e configurar contas eletrônicas, IMAP e outras
-  Data e hora – permite ajustar data e hora
-  Informações sobre o dispositivo – visualiza informações sobre o dispositivo e o sistema, número de modelo, etc.

Izgled i gumbad

Gumb napajanja (POWER)

Uključivanje i isključivanje uređaja. Gumb napajanja sastavljen je od glavne gumba.

Blokada zvučnika (gumb napajanja i "Power") nastupa kada je blokada zvučnika.

Jačina zvuka, Jačina zvuka, Gumbadignost, "Volumen" i "Volume" i "Volume" i "Volume".

Gnjezd za slušalice – Gnjezd za standardni glasnik, 3,5 mm.

Kartica memorije – Otvor za karticu za memoriju FLASH.

MikroUSB – zaspajanje i prenos podataka. Spajanje spoljnog uređaja za prenos podataka.

Opis glavnog ekrana

Nakon uključanja, pojavit će se glavni ekran.

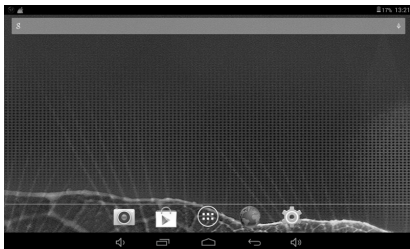

Upravljanje ikonama softvera: nakon 3 sekunda pretiskanja ikone, ona će se povećati i tada je moguće prevući u dovoljno mjesto na ekranu.

Uklanjanje ikona: nakon 3 sekunda pritiskanja, prevući ikonu na ikonu „košnica za smjeć“, i kada će postati crvena, možeš nju pustiti, nakon čega ikonu ukloniš.

Opis trake stanja

Traka stanja dole na ekranu.



S lijeva: tipku glasnoće, poništavanjem gumb, povratak na početni zaslom, zadnji otvoreni volumen aplikacija + gumb.

Traka stanja pri vrhu zaslona.



S desna lijeve strane prikazani su statusni elementi, uključujući vrijeme i bateriju sustava.

Priključivanje računara

Koristeći priključak USB za spajanje MID s računarom. Pojavit će se simbol ikone USB, a nakon prevučenja i ubačenja trake stanja, pojavit će se sljedeći ekran:

Natisni „Turn on USB storage” („Uključi disk USB”).

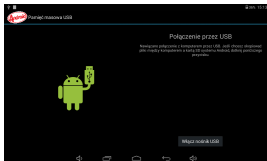

Postavke



Wi-Fi omogućuje konfiguraciju i povezivanje s Wi-Fi mrežama – omogućuje konfiguraciju sustavnih zvučnih obavijesti



Display – omogućuje konfiguraciju zaslona (Svijetlost ekrana, Pozadinska slika, Hibernacija itp.)



Memorija – prikazuje kolika je slobodna i zauzeta memorija



Baterija – prikazuje vrijeme rada, status baterije, način napajanja od strane aplikacija



Jezik, tipkovnica, glas – omogućuje izbor jezika, tipkovnice, konfiguraciju funkcija glasovne upravljačke jedinice



Kopiranje – omogućuje stvaranje kopija sustavnih postavki i postavki aplikacija



Dodavanje – omogućuje dodavanje i konfiguraciju Googlea i drugih aplikacija



Datumi i vrijeme – omogućuje postavljanje datuma i vremena



Informacije o uređaju – Prikazuje informacije o uređaju, verziju sustava, broj modela itd.

Vzhled a tlačítka

Tlačítka a pájeň (POWER)

Za pán í poz m ak nu áid eš í mp ý dže n fl aít ka a pá je n p ý j de y st é m n a h l a v o b r a z o v k u .

Z a b l o k á n í o b r a z o v k y k : á t k é m m a k n u t í a í t k a a pá je n (i „ P o w e r ” d o c á z í k z a b l o k á n í e b o d b l o k á n í o b r a z o v k y .

H l a s í t o s t , H l a s í t o s t - T l a í t k a n a h l a s í t k a „ V O L U M E + , V O L U M E - e h l a s í t o s t ů j e n e b o ň ů j e .

K o n e k t o r o s l u c h á t k a - K o n e k t s t r a n d a r d k l o n o e k t o r o s l u c h á t k a 3 , 5 m m .

P a m e o v á k a r t a S l o t F - C A R d : e r p m á m e o v á k a r t a F F L A S H .

M i k r o U S B - p r o p ý p o j e n í o í t a e k p ř e n o s d a t a p ý p o j e n í e x t e r n í h o U S B l a s d i s k u .

Popis hlavní obrazovky

Po zapnutí se zobrazí hlavní obrazovka.

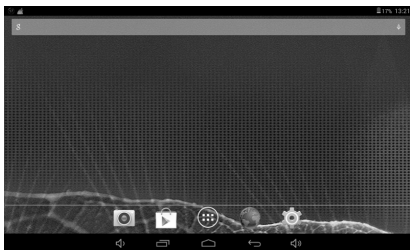

Správa programových ikon: po stisknutí ikony po dobu 3 sekund se ikona zvětší a bude možné ji přetáhnout na libovolné místo.

Odstranění ikon: po stisknutí po dobu 3 sekund přetáhněte ikonu na ikonu koše, a když zčervená, můžete ikonu pustit, čímž ikonu odstraní.

Popis stavového řádku

Stavový řádek v dolní části obrazovky.



Zleva: Objem tlačítkem, couvací tlačítko, vrátíte na hlavní obrazovku, poslední svazek otevřené aplikace + tlačítko.

Stavový řádek v horní části obrazovky.



Zprava doleva: ikony stavu baterie, v nastaveném čase, systémové ikony.







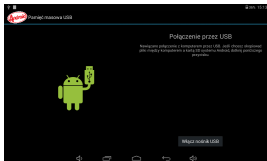



Připojení počítače

Při použití portu USB pro spojení MID s počítačem se zobrazí symbol ikony USB a po přetažení a puštění stavového řádku, se zobrazí následující obrazovka:

Stiskněte „Turn on USB storage“ („Zapněte nosič USB“).



Nastavení

-  Wi-Fi-uměňuje konfiguraci a spojení se sítí Wi-Fi.
-  Zvuk-uměňuje konfiguraci systémového zvuku a ticha.
-  Displej-uměňuje konfiguraci displeje (světelnost, Téma, Rozlišení, Režim spánku, apod.).
-  Paměť-zobrazuje stav volné a využívané paměti.
-  Baterie-zobrazuje dobu provozu baterie aplikacemi.
-  Jazyk a klávesnice, hlas-uměňuje volbu jazyka klávesnice, konfiguraci hlasových funkcí.
-  Kopie a odstránění-uměňuje vytvořit kopii systému a obnovit tovární nastavení.
-  Přidání-uměňuje přidat a nakonfigurovat Google Play, PAMAP a jiné.
-  Datum a čas-uměňuje nastavit datum a čas.
-  Informace o zařízení-zobrazuje Informace o zařízení systému, modelu, atd.

Dizainas ir mygtukai

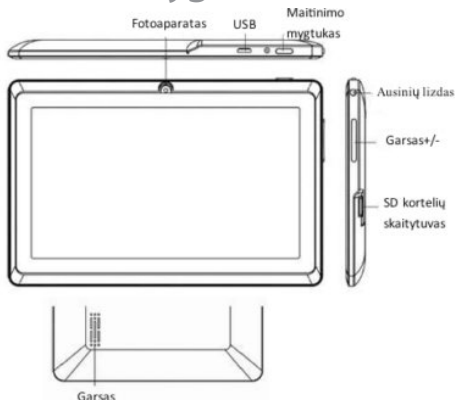

Maitinimo mygtukas (POWER) jungiamas paspausiant ilgą laiką vieną iš mygtukų, sistema pereis į gryną ekraną.

Ekraną atidaryti trumpai paspausiant gaminio mygtuką „Power“ vyksta kraštinis aktyvavimas ir atnaujinimas.

Garsas Garsas – mygtukai skirti didinti ir sumažinti garsą. „Volume“ mygtukai padidina arba sumažina garsą.

Ausinių liuzdas – standartinis 3,5 mm stereo ausinių liuzdas.

Atminties kortelė – TF KORTELIŠKAS lizdas. Įstatantminties FLASH kortelę.

Micro USB – prijungti kompiuterą, per du duomenis prijungti į USB atmintuką.

Pagrindinio ekrano aprašymas

Po pajungimo pasirodys pagrindinis ekranas.

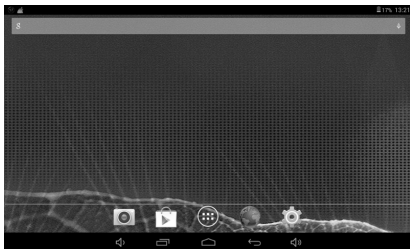

Programavimo piktogramų valdymas: kai paspausite ant piktogramos per 3 sekundes, ji bus padidinta ir galėsite vilkti ją į bet kurią vietą ekrane.

Piktogramos šalinimas: kai paspausite per 3 sekundes, vilkite piktogramą į šiukšlinę, o kai ji pavirs raudona, galite ją paleisti, ir tada pašalinti piktogramą.

Būsenos juostos aprašymas

Būsenos juosta ekrano apačioje.



Iš kairės: garso mygtuką, atbulinės eigos mygtukas, grįžti į pagrindinį ekraną, paskutinį atvirą taikymo apimtis + mygtuką.

Būsenos juostoje ekrano viršuje.



Iš dešinės į kairę: akumuliatoriaus būsenos piktograma, nustatytu laiku, sistemos piktogramos.







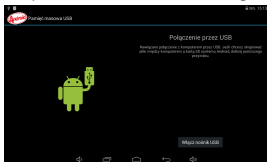



Kompiuterio prijungimas

Naudojant USB jungtį kad prisijungti MID prie kompiuterio. Pasirodys USB piktogramos simbolis, o kai vilksite ir paleisite būsenos juosta, pasirodys toks ekranas:

Paspauskite „Turn on USB storage“ („Įjunkite USB laidą“).



Nustatymai

-  **Wi-Fi** – leidžia konfigūruoti ir prisijungti prie Wi-Fi tinklo
-  **Garsas** – leidžia konfigūruoti sistemos garsus ir pranešimus
-  **Ekranas** – leidžia konfigūruoti ekraną (Ekranų ryškumas, Tapetai, Miego režimas, ir t. t.)
-  **Atmintis** – parodo laisvos ir užimtos atminties kiekį
-  **Baterija** – parodo darbo laiką su baterija bei taikomosios programinės įrangos naudojimą
-  **Kalba, klaviatūra, garsas** – leidžia pasirinkti kalbą, klaviatūrą, balso funkcijų konfigūraciją
-  **Kopija ir duomenų naikinimas** – leidžia sistemo kopijų formavimą bei gamyklinių nustatymų atkūrimą
-  **Pridėli pašta** – leidžia pridėti ir konfigūruoti Google, Pašto, IMAP ir kitus paštus
-  **Data ir laikas** – leidžia nustatyti datą ir laiką
-  **Įrenginio informacija** – rodo informaciją apie įrenginį, sistemos versiją, modelio numerį ir t.



INFORMACJA O PRAWIDŁOWYM POSTĘPOWANIU W PRZYPADKU UTYLIZACJI URZĄDZEŃ ELEKTRONICZNYCH I ELEKTRYCZNYCH

Umieszczony na naszych produktach symbol przekreślonego kosza na śmieci informuje, że nieprzydatnych urządzeń elektrycznych czy elektronicznych nie można wyrzucać razem z odpadami gospodarczymi.

Właściwe działanie w wypadku konieczności utylizacji urządzeń czy podzespołów lub ich recyklingu polega na oddaniu urządzenia do punktu zbiórki, w którym zostanie ono bezpłatnie przyjęte. W niektórych krajach produkt można oddać podczas zakupu nowego urządzenia.

Prawidłowa utylizacja urządzenia daje możliwość zachowania naturalnych zasobów Ziemi na dłużej i zapobiega degradacji środowiska naturalnego. Informacje o punktach zbiórki urządzeń wydają właściwe władze lokalne.

Nieprawidłowa utylizacja odpadów zagrożona jest karami przewidzianymi prawem obowiązującym na danym terenie.

Dział Obsługi Klienta

tel: +48 22 332 34 63 lub e-mail: serwis@manta.com.pl

od poniedziałku do piątku w godz. 9.00-17.00

Producent zastrzega sobie możliwość wprowadzenia zmian w specyfikację produktu bez uprzedzenia.

Strona główna www.manta.com.pl

Strona wsparcia technicznego www.manta.info.pl